



Wi-Fi® HD Motorized Video Baby Camera



User Guide

Models: PIP1010 CONNECT

Safety instructions

WARNING

Strangulation Hazard. Children have STRANGLED in cords. Keep this cord out of the reach of children (more than 1 meter or 3 feet away). Do not remove the tags from the AC Adapters. Only use the AC Adapters provided.

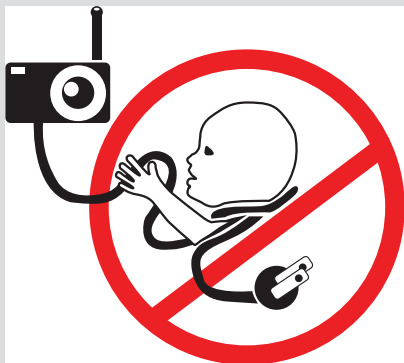

Baby Camera setup and use:

- Choose a location for the baby unit that will provide the best view of your baby in their crib.
- Place the baby unit on a flat surface, such as a dresser, desk, shelf or wall mount the unit securely with the wall mount bracket provided in the pack.
- NEVER place the baby unit or cords in the crib or within reach of the baby (the unit and cords should be more than 3 feet away).

WARNING

This Smart Video Baby Camera is compliant with all relevant standards regarding electromagnetic fields and is, when handled as described in the User Guide, safe to use. Therefore, always read the instructions in this User Guide carefully before using the device.

- Adult assembly is required. Keep small parts away from children when assembling.
- This product is not a toy. Do not allow children to play with it.
- This baby camera is not a substitute for responsible adult supervision.
- Keep this User Guide for future reference.
- Do not place the baby (camera) unit or cords in the crib or within reach of the baby (the unit and cords should be more than 3 feet away).
- Keep the cords out of reach of children.
- Do not cover the baby camera with a towel, blanket, or other item that will stop air circulation.
- Never use extension cords with power adapters. Only use the power adapters provided.
- Test this camera and all its functions so that you are familiar with it prior to actual use.
- Do not use the baby camera near water or allow water or other foreign substances to enter the power port or adapter.
- Do not place the Baby Camera near a heat source.
- Only use the chargers and power adapters provided. Do not use other chargers or power adapters as this may damage the device and battery packs.
- Do not touch the plug contacts with sharp or metal objects.
- The unit should be set up and used so that parts of the user's body other than the hands are maintained at a distance of approximately 8 inches (20 cm) or more.
- The wall mounting height is less than 2 m for the baby unit.

Welcome...

to your new Smart Video Baby Camera!

Thank you for purchasing your new Smart Nursery product. Now you can see and hear your baby sleeping in another room or you can monitor your older children in their playroom.

Important

To use your baby camera, you must be able to establish a Wi-Fi link between your baby camera and your Wi-Fi router, and the range will be affected by environmental conditions.

Any large metal object, like a refrigerator, a mirror, a filing cabinet, a metallic door or reinforced concrete between the baby camera and the Wi-Fi router may block the radio signal.

The signal strength may also be reduced by other solid structures, like walls, or by radio or electrical equipment, such as TVs, computers, cordless or mobile phones, fluorescent lights or dimmer switches.

Other 2.4GHz products, Bluetooth™ systems, microwave ovens or other baby monitors, may cause interference with this product, so keep the baby camera at least 5 ft (1.5 m) away from these types of products, or switch them off if they appear to be causing interference.

If the signal is weak, try moving the baby camera to different positions in rooms.

Need help?

If you have any problems setting up or using your **PIP1010 CONNECT**, please visit us at: motorolanursery.com/support

Alternatively, you may find the answer in the 'Help' section at the back of this guide.

This User Guide provides you with all the information you need to get the most from your Smart Video Baby Camera.

Read the instructions carefully, and be aware that this Smart Video Baby Camera is only intended as an aid. It is not a substitute for responsible and proper adult supervision.

Before you use the Smart Video Baby Camera, follow the simple instructions in ‘Getting started’, on the next few pages.

Important

Use only the supplied power adapter (DC5V / 1000 mA).

Got everything?

- Baby (camera) unit
- AC power adapter for the baby (camera) unit
- Wall mount bracket and screws

If you have purchased multi camera pack, you will also have the following additional items:

- Baby (camera) unit(s)
- AC power adapter(s) for the baby (camera) unit(s)

For Wi-Fi® internet viewing you will need a suitable Android or iPhone/iPad device and Wi-Fi® internet connection of at least 0.6 Mbps upload bandwidth per baby (camera) unit.

1.	Getting started	7
2.	Getting to know your baby camera	9
3.	Viewing the baby through your device.....	11
3.1	Minimum System Requirements.....	11
3.2	Connect your device.....	11
3.3	Set up the camera.....	11
3.3.1	Set up user account and camera on your devices.....	12
3.3.2	Connect the Camera.....	12
3.3.3	Download the app.....	12
3.3.4	Sign up or log in to the app.....	12
3.3.5	Add a camera to your account.....	13
3.4	Reset the camera	13
4.	Help.....	14
5.	Technical Specifications.....	15
6.	General information.....	16

1. Getting started

Location

Important

Do not place your **PIP1010 CONNECT** in the bathroom or other humid areas.

Place your units within reach of the AC power outlet and wall socket. The socket-outlet should be installed near the equipment and should be easily accessible.

Setting up

Important

The baby (camera) unit must be plugged into the wall socket at all times. Use only the AC power adapter supplied with the product.

Connecting the baby (camera) unit

You will need to carry out this process for the single or multi baby (camera) units.

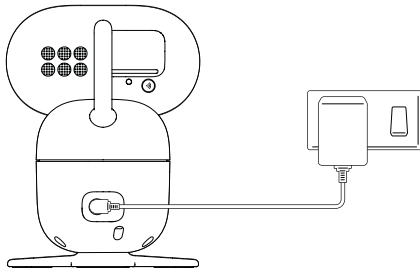

1. Plug the DC plug of the power adapter into the power socket on the rear of the baby (camera) unit and plug the other end of the AC adapter into the wall socket.
2. The baby unit turns on and the power indicator lights up in blue first and changes to red flashing if not paired to the **Motorola Nursery App**.

Your PIP1010 CONNECT is now ready for use.

2. Getting to know your baby camera

Overview of your baby (camera) unit

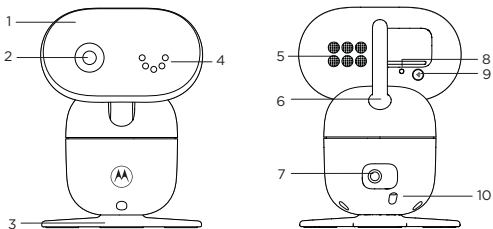

- 1. High intensity infrared LEDs behind the black lens**
Picks up clear images in the dark when the built-in photo sensor detects a low level of ambient light, the screen on your smart phone will turn black and white.
- 2. Camera**
- 3. Desk stand**
- 4. Microphone**
Picks up the sound from the baby.
Note: Make sure you remove any cover or protective tape on it.
- 5. Speaker**
- 6. Antenna**
- 7. Power jack**
- 8. Power / Linking LED indicator**
Lights up in blue when the baby (camera) unit is powered on and linked to the **Motorola Nursery App**.
- 9. Pair button**
Press and hold to pair with the **Motorola Nursery App**.
- 10. Temperature sensor (Night vision mode)**
The temperature reading from the temperature sensor at the back of the baby unit will be displayed on the smart phone.

Wall mount the baby (camera) unit

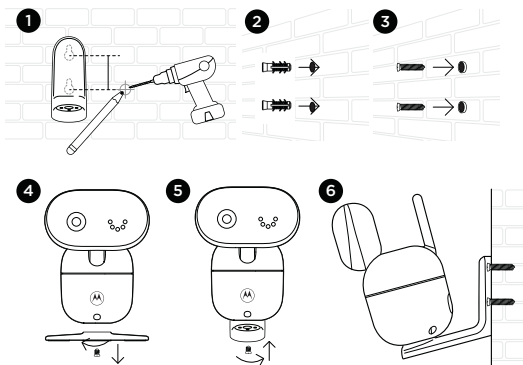

1. Mark the positions of 2 screw holes on the wall. Drill a screw hole at each marking.
2. Install the supplied wall anchors into 2 screw holes on the wall.
3. Insert the supplied wall mounting screws into the wall anchors.
4. Remove the desk stand by loosening the screw on the underside of the desk stand.
5. Fix and fasten this screw on the baby (camera) unit and the wall mount bracket.
6. Hang the wall mount bracket on the wall mounting screws on the wall.

Note

The pack includes a power adapter with a longer cord which is beneficial for wall mount application, where your wall socket is far from the camera.

3. Viewing the baby through your device

3.1 Minimum System Requirements

Android™ System

- Version 7.0 or above

iPhone®/iPad® iOS

- Version 10.0 or above

High Speed (Wi-Fi®) Internet

- At least 0.6 Mbps upload bandwidth per camera (you can test your internet speed on this site: <http://www.speedtest.net>).

3.2 Connect your device

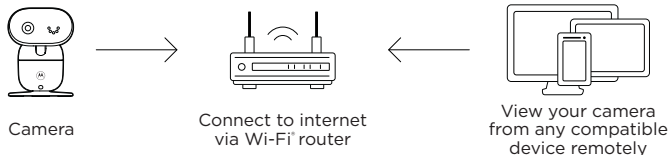

When a user tries to access the Wi-Fi® camera (baby unit), our server authenticates the user's identity and permits access to the Wi-Fi® camera (baby unit).

Note

You can only set up through a compatible smartphone or tablet but not through a PC.

3.3 Set up the camera

Connect the Wi-Fi® camera (baby unit) to the power adapter, then plug into the wall socket. The camera must be within range of the Wi-Fi® router with which you want to connect. Make sure the password of the router is available for entering during the in-app setup process.

The following table shows the meanings of different LED connection status.

State	LED indication
Pair / Setup	Flashes blue and red
Connected	Solid blue
Video streaming	Solid blue

3.3.1 Set up user account and camera on your devices

You will need:

- Wi-Fi® camera (baby unit)
- Power adapter for the camera
- Device with Android™ system version 7.0 and above, or
- iPhone®/iPad® with iOS version 10.0 and above

3.3.2 Connect the Camera

1. Switch off any parent unit in case you have, before connecting the camera (baby unit) to Wi-Fi®.
2. Connect the power adapter to the power outlet and insert the plug into the power socket on the back of the camera (baby unit). The camera turns on.

3.3.3 Download the app

1. Scan the QR code with your smart device and download the **Motorola Nursery App** from App Store for iOS devices or from Google Play™ Store for Android™ devices.



2. Install the app on your device.

3.3.4 Sign up or log in to the app

1. Ensure that your smart device is connected to your Wi-Fi® router.
2. Follow the on-screen instructions to run and sign up or log in to the app.

3.3.5 Add a camera to your account

1. Log in to the app.
2. Tap **Devices**, and then tap  on the device screen to add a new camera.
3. Tap (your baby camera model's name) to add the new camera.
4. Select and enter the password of your Wi-Fi® network and then tap **Next**.
5. Power on the camera and tap **Continue** on the app.
6. Press and hold **PAIR** at the bottom of the camera. The LED flashes blue and red.
7. Tap **Continue** on your device when you hear the voice prompt '**Ready for pairing**'.
8. Tap **Generate QR code** on your device and hold the QR code 15 cm to 30 cm in front of the camera to get scanned till you will hear a confirmation message '**Pairing success**' from your device.
9. Tap **Complete** when it is successfully connected. It may take a few minutes for the camera to connect to the Wi-Fi® network.
10. If connection fails, tap **Retry** and repeat steps 1 - 10 in this section.

3.4 Reset the camera

You will need to reset your camera if you relocate your camera from one router to another.

1. Press and hold  for about 20 seconds. Release it when you hear the voice prompt '**Reset camera**'. The camera is reset successfully.
2. Follow the section 4.3.5 to add the camera again.

4. Help

No sound or the audio level is low.

- Make sure that the protective tapes on the baby (camera) units are removed.

Loss Connection

- Check your Wi-Fi® settings and reconnect your Wi-Fi® if necessary. Ensure the baby (camera) unit is switched on. Wait for a few minutes for the baby (camera) unit to connect with the Wi-Fi® system.

Forgot the password

- If you do not remember your password, tap **Forgot Password** and submit your email address. A new password will be sent to your e-mail address immediately.

System Reset

- When problems such as lost connection, no sound and no video cannot be fixed based on the above guides, you can try to do a system reset. Note that after system reset, you will need to do the pairing to the app and the parent unit again.

system reset for the parent unit: on the the left hand side of the parent unit and on the top of the DC socket, there is a small hole. Use a small pin to insert and press into it. The parent unit will go through system reset.

system reset of the camera unit: follow the procedure as described in section 3.4 of this user guide.

5. Technical Specifications

RF frequency bands	2400 MHz to 2483.5 MHz
Operating range	0 °C - 40 °C or 32 °F - 104 °F
Baby unit Image sensor	Color CMOS 2M Pixels
Power adapter for the baby and parent units	Input: 100-240V AC, 50/60Hz, 300mA or 400mA; Output: 5.0V DC, 1000mA

WARNING

Use only with provided power adaptor:

Dongguan Becky Electronics Tech Co., Ltd. (BQ05A-0501000-U)

Input 100-240V AC, 50/60Hz, 300mA;

Output: 5.0V DC, 1000mA

or

Dongguan Everest Industrial Co., Ltd. (EP04-050100WXLZ)

Input : 100-240V AC, 50/60Hz, 200mA;

Output : 5.0V DC, 1000mA

or

ShenZhen Baijunda Electronic Co., Ltd. (AT-538A-050100A)

Input : 100-240V AC, 50/60Hz, 200mA;

Output : 5.0V DC, 1000mA

Note

Specifications are subject to change without prior notice.

6. General information

Cleaning and care

Important

Always switch off and disconnect the power adapter before cleaning your video baby camera.

- Clean your video baby camera with a slightly damp cloth or with an anti-static cloth. Never use cleaning agents or abrasive solvents.
- Do not clean any part of the video baby camera with thinners or other solvents and chemicals - this may cause permanent damage to the product which is not covered by the warranty.
- Keep your video baby camera away from hot, humid areas or strong sunlight, and do not let it get wet.
- Every effort has been made to ensure high standards of reliability of your Video Baby Camera. However, if something does go wrong, please do not try to repair it yourself - contact Customer Service for assistance.

Product Disposal Instructions

Product disposal instructions for residential users

When you have no further use for it, please remove any batteries and dispose of them and the product according to your local authority's recycling processes. For more information, please contact your local authority or the retailer where the product was purchased.



Product disposal instructions for business users

Business users should contact their suppliers and check the terms and conditions of the purchase contract and ensure that this product is not mixed with other commercial waste for disposal.



Consumer Products and Accessories Warranty

Thank you for purchasing this Motorola branded product manufactured under license by Meizhou Guo Wei Electronics Co. LTD., AD1 section, The economy exploitation area, Meizhou, Guangdong, P.R.China . ("MZGW").

What Does this Warranty Cover?

Subject to the exclusions contained below, MZGW warrants that this Motorola branded product ("Product") or certified accessory ("Accessory") sold for use with this product that it manufactured to be free from defects in materials and workmanship under normal consumer usage for the period outlined below. This Limited Warranty is your exclusive warranty and is not transferable.

Who is covered?

This warranty extends only to the first consumer purchaser, and is not transferable.

What will MZGW do?

MZGW or its authorized distributor at its option and within a commercially reasonable time, will at no charge repair or replace any Products or Accessories that do not conform to this limited warranty. We may use functionally equivalent reconditioned / refurbished / pre-owned or new Products, Accessories or parts.

What Other Limitations Are There?

ANY IMPLIED WARRANTIES, INCLUDING WITHOUT LIMITATION THE IMPLIED WARRANTIES OF MERCHANTABILITY AND FITNESS FOR A PARTICULAR PURPOSE, SHALL BE LIMITED TO THE DURATION OF THIS LIMITED WARRANTY, OTHERWISE THE REPAIR OR REPLACEMENT PROVIDED UNDER THIS EXPRESS LIMITED WARRANTY IS THE EXCLUSIVE REMEDY OF THE CONSUMER, AND IS PROVIDED IN LIEU OF ALL OTHER WARRANTIES, EXPRESS OF IMPLIED. IN NO EVENT SHALL MOTOROLA OR MZGW BE LIABLE, WHETHER IN CONTRACT OR TORT (INCLUDING NEGLIGENCE) FOR DAMAGES IN EXCESS OF THE PURCHASE PRICE OF THE PRODUCT OR ACCESSORY, OR FOR ANY INDIRECT, INCIDENTAL, SPECIAL OR CONSEQUENTIAL DAMAGES OF ANY KIND, OR LOSS OF REVENUE OR PROFITS, LOSS OF BUSINESS, LOSS OF INFORMATION OR OTHER FINANCIAL LOSS ARISING OUT OF OR IN CONNECTION WITH THE ABILITY OR INABILITY TO USE THE PRODUCTS OR ACCESSORIES TO THE FULL EXTENT THESE DAMAGES MAY BE DISCLAIMED BY LAW.

Some jurisdictions do not allow the limitation or exclusion of incidental or consequential damages, or limitation on the length of an implied warranty, so the above limitations or exclusions may not apply to you. This warranty gives you specific legal rights, and you may also have other rights that vary from one jurisdiction to another.

Products Covered	Length of Coverage
Consumer Products	Two (2) years from the date of the products original purchase by the first consumer purchaser of the product.
Consumer Accessories (battery, power supply(s) and line cords)	Ninety (90) days from the date of the accessories original purchase by the first consumer purchaser of the product.
Consumer Products and Accessories that are Repaired or Replaced	The balance of the original warranty or for ninety (90) days from the date returned to the consumer, whichever is longer.

Exclusions

Normal Wear and Tear. Periodic maintenance, repair and replacement of parts due to normal wear and tear are excluded from coverage.

Batteries. Only batteries whose fully charged capacity falls below 80% of their rated capacity and batteries that leak are covered by this limited warranty.

Abuse & Misuse. Defects or damage that result from: (a) improper operation, storage, misuse or abuse, accident or neglect, such as physical damage (cracks, scratches, etc.) to the surface of the product resulting from misuse; (b) contact with liquid, water, rain, extreme humidity or heavy perspiration, sand, dirt or the like, extreme heat, or food; (c) use of the Products or Accessories for commercial purposes or subjecting the Product or Accessory to abnormal usage or conditions; or (d) other acts which are not the fault of Motorola or MZGW are excluded from coverage.

Use of Non-Motorola branded Products and Accessories. Defects or damage that result from the use of Non-Motorola branded or certified Products or Accessories or other peripheral equipment are excluded from coverage.

Unauthorized Service or Modification. Defects or damages resulting from service, testing, adjustment, installation, maintenance, alteration, or modification in any way by someone other than Motorola, MZGW or its authorized service centers, are excluded from coverage.

Altered Products. Products or Accessories with (a) serial numbers or date tags that have been removed, altered or obliterated; (b) broken seals or that show evidence of tampering; (c) mismatched board serial numbers; or (d) nonconforming or non-Motorola branded housings, or parts, are excluded from coverage.

Communication Services. Defects, damages, or the failure of Products or Accessories due to any communication service or signal you may subscribe to or use with the Products or Accessories is excluded from coverage.

How to Obtain Warranty Service or Other Information?

To obtain service or information, please visit us at:
motorolanursery.com/support

You will receive instructions on how to ship the Products or Accessories at your expense and risk, to a MZGW Authorized Repair Center.

To obtain service, you must include: (a) the Product or Accessory; (b) the original proof of purchase (receipt) which includes the date, place and seller of the Product; (c) if a warranty card was included in your box, a completed warranty card showing the serial number of the Product; (d) a written description of the problem; and, most importantly; (e) your address and telephone number.

EU Declaration of Conformity (DoC)

Hereby, Meizhou Guo Wei Electronics Co. LTD declares that the product is in compliance with RE Directive 2014/53/EU. The full text of the EU declaration of conformity is available on the website: motorolanursery.com.

FCC and IC regulations

FCC Caution:

Any changes or modifications not expressly approved by the party responsible for compliance could void the user's authority to operate the equipment.

This device complies with part 15 of the FCC Rules. Operation is subject to the following two conditions: (1) This device may not cause harmful interference, and (2) this device must accept any interference received, including interference that may cause undesired operation.

IMPORTANT NOTE:

Note: This equipment has been tested and found to comply with the limits for a Class B digital device, pursuant to part 15 of the FCC Rules. These limits are designed to provide reasonable protection against harmful interference in a residential installation. This equipment generates, uses and can radiate radio frequency energy and, if not installed and used in accordance with the instructions, may cause harmful interference to radio communications. However, there is no guarantee that interference will not occur in a particular installation. If this equipment does cause harmful interference to radio or television reception, which can be determined by turning the equipment off and on, the user is encouraged to try to correct the interference by one or more of the following measures:

- Reorient or relocate the receiving antenna.
- Increase the separation between the equipment and receiver.
- Connect the equipment into an outlet on a circuit different from that to which the receiver is connected.
- Consult the dealer or an experienced radio/TV technician for help.

ISED Warning

This device complies with Innovation, Science, and Economic Development Canada licence-exempt RSS standard(s). Operation is subject to the following two conditions:

- (1) this device may not cause interference, and
- (2) this device must accept any interference, including interference that may cause undesired operation of the device.

Le présent appareil est conforme aux CNR d'Innovation, Sciences et Développement économique Canada applicables aux appareils radio exempts de licence. L'exploitation est autorisée aux deux conditions suivantes :

- (1) l'appareil ne doit pas produire de brouillage, et
- (2) l'utilisateur de l'appareil doit accepter tout brouillage radioélectrique subi, même si le brouillage est susceptible d'en compromettre le fonctionnement.

Radiation Exposure Statement:

The baby unit complies with FCC/ISED radiation exposure limits set forth for an uncontrolled environment. The baby unit should be installed and operated with minimum distance 20cm between the radiator & your body. The parent unit has been tested and comply with FCC and ISED SAR limits.

Déclaration d'exposition aux radiations:

L'unité bébé est conforme aux limites d'exposition aux rayonnements FCC / ISED établies pour un environnement non contrôlé. L'unité bébé doit être installée et utilisée avec une distance minimale de 20 cm entre le radiateur et votre corps.

L'unité parent a été testée et est conforme aux limites SAR FCC et ISED.

Manufactured, distributed or sold by Meizhou Guo Wei Electronics Co. LTD., official licensee for this product. MOTOROLA and the Stylized M Logo are trademarks or registered trademarks of Motorola Trademark Holdings, LLC. and are used under license. All other trademarks are the property of their respective owners. © 2022 Motorola Mobility LLC. All rights reserved.

Version 1.0 (EN-EU&US)

